

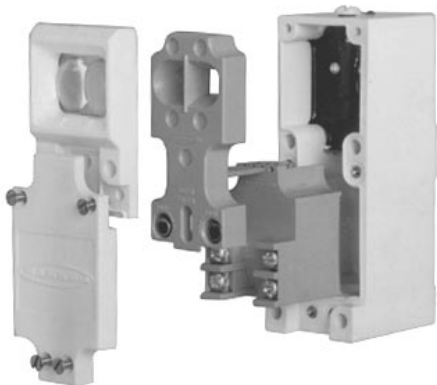

MULTI-BEAM[®] Sensors

Compact modular self-contained photoelectric sensing controls

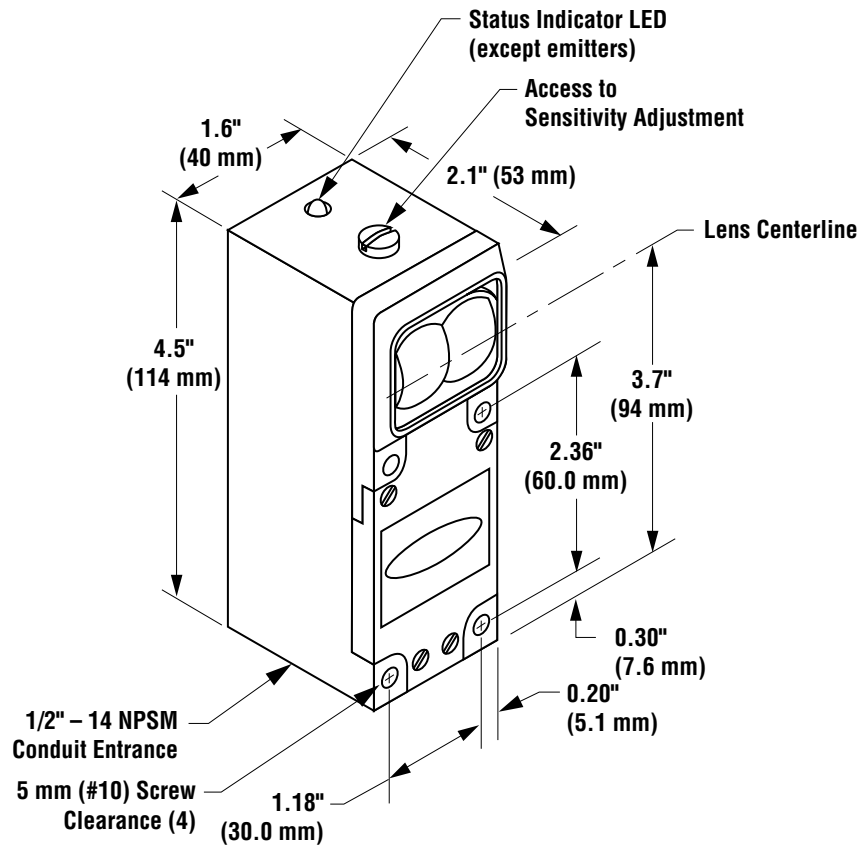

- Modular design with interchangeable components (scanner blocks, power blocks, and logic timing modules); over 5,000 sensor configurations possible
- *Scanner blocks* for opposed, retro, diffuse, convergent, and fiber optic sensing modes (including high-gain models)
- *Power blocks* for ac or dc operation, including 2-wire ac operation
- *Logic modules* to support a wide variety of delay, pulse, limit, and rate sensing logic functions
- Most scanner blocks include Banner's exclusive, patented AID™ (Alignment Indicating Device) system, which lights a top-mounted indicator LED whenever the sensor sees its own modulated light source, and pulses the LED at a rate proportional to the strength of the received light signal.

MULTI-BEAM[®] Sensors

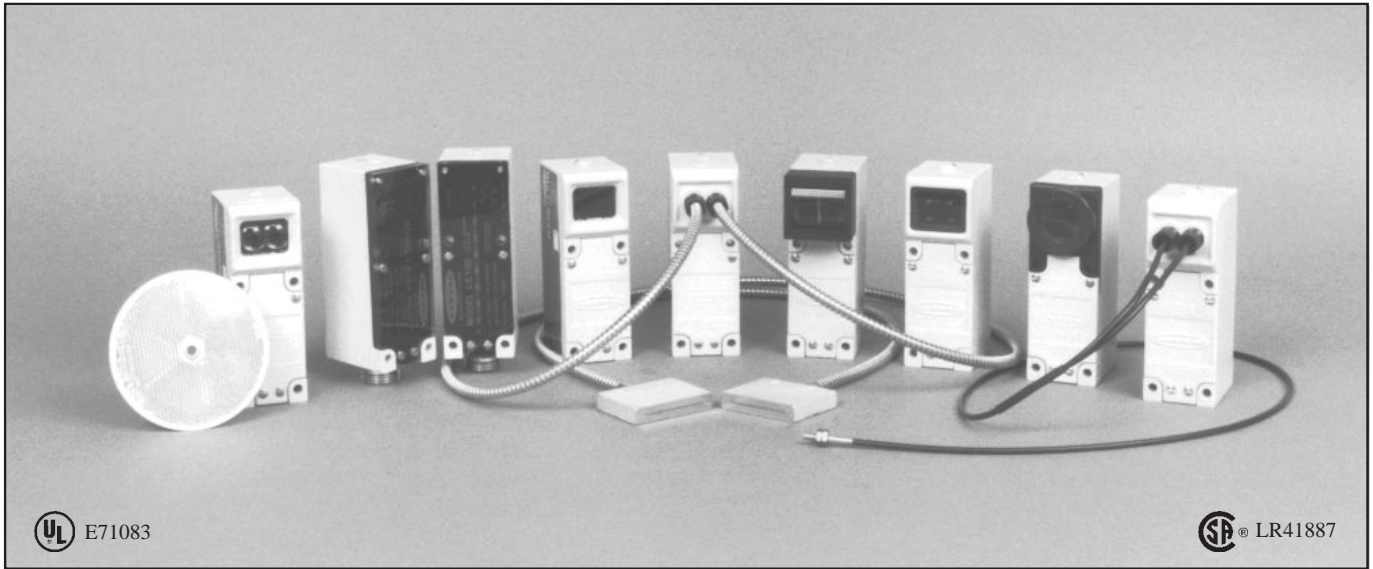

UL E71083

SP[®] LR41887

Banner MULTI-BEAM[®] sensors are compact *modular* self contained photoelectric switches. Each MULTI-BEAM consists of three components: scanner block, power block, and logic module. The *scanner block* contains the complete modulated photoelectric amplifier as well as the emitter and receiver optoelements. It also contains the sensing optics and the housing for the other two modules. The *power block* provides the interface between the scanner block and the external circuit. It contains a power supply for the MULTI-BEAM plus a switching device to interface the circuit to be controlled. The *logic module* interconnects the power block and scanner block both electrically and mechanically. It provides the desired timing logic function (if any), plus the ability to program the output for either light- or dark-operate. The emitters of MULTI-BEAM emitter-receiver pairs do not require a logic module. Emitter scanner blocks are supplied with a blade-pin to interconnect the scanner block and power block. This modular design, with field-replaceable power block and logic module, permits over 5,000 sensor configurations, resulting in exactly the right sensor for any photoelectric application.

There are two families of MULTI-BEAM sensors: 3- and 4-wire, and 2-wire. Three- and four-wire MULTI-BEAMS offer the greatest selection of sensor configurations. They permit either ac or dc operation and offer the fastest response times and the greatest sensing ranges. Two-wire MULTI-BEAMS are used in ac-powered applications where simplicity and convenience of wiring are important. They are physically *and* electrically interchangeable with heavy-duty limit switches.

The circuitry of all MULTI-BEAM components is encapsulated within rugged, corrosion-resistant VALOX[®] housings, which meet or exceed NEMA 1, 3, 12, and 13 ratings. Most MULTI-BEAM scanner blocks include Banner's patented Alignment Indicating Device (AID[™]) which lights a top-mounted LED when the sensor sees its own modulated light source and pulses the LED at a rate proportional to the received light signal. Most MULTI-BEAM sensor assemblies are UL listed and certified by CSA (see power block listings). All MULTI-BEAM components (except power block models 2PBR and 2PBR2) are totally solid-state for unlimited life.

Composite Functional Schematic, 3- and 4-wire Sensors

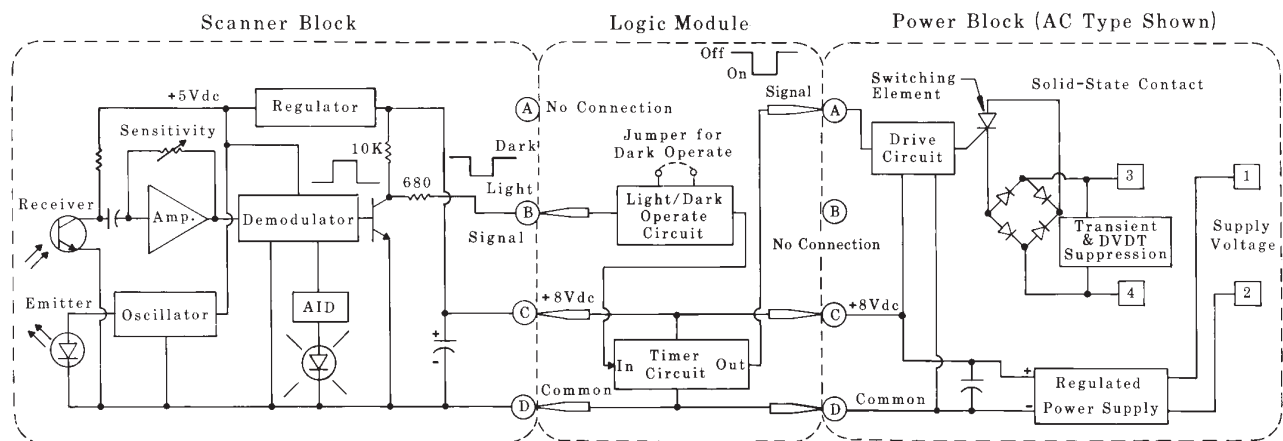

Selection of MULTI-BEAM Components

MULTI-BEAM sensors are made up of three components: scanner block, power block, and logic module. This is true for all MULTI-BEAMs with the exception of opposed mode emitter units which require only a power block (no logic module).

The first decision in the component selection process is to determine which family of MULTI-BEAM sensors is appropriate for the application: 3- and 4-wire, or 2-wire.

Next, decide which scanner block (within the selected family) is best for the application. The guidelines in the catalog introduction will help you to determine the best sensing mode. Then narrow the choice by comparing the specifications listed in the following charts and on the pages referenced in the charts.

Finally, choose a power block and logic module to complete the MULTI-BEAM assembly. Components snap together without inter-wiring to form a complete photoelectric sensing system that meets your exact requirements while maintaining the simplicity of a self-contained sensor.

If you have any questions about selecting MULTI-BEAM components, please contact your Banner sales engineer or call Banner's Applications Department at (612) 544-3164 during normal business hours.

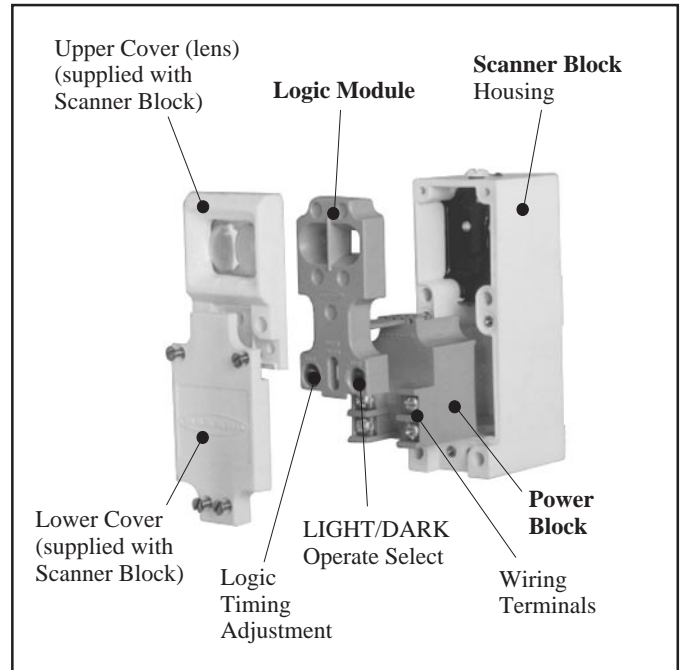

3- and 4-wire Systems (pages 6 through 23)

Scanner Blocks	Model	Sensing Mode	Range	Response	Page
	SBE & SBR1	Opposed: high speed	150 feet	1 millisecond	p. 7
	SBED & SBRD1	Opposed: high speed, narrow beam	10 feet	1 millisecond	p. 7
	SBEX & SBRX1	Opposed: high power, long range	700 feet	10 milliseconds	p. 7
	SBEV & SBRX1	Opposed: visible beam	100 feet	10 milliseconds	p. 7
	SBEXD & SBRXD1	Opposed: high power, wide beam angle	30 feet	10 milliseconds	p. 7
	SBLV1	Retroreflective: high speed, visible beam	30 feet	1 millisecond	p. 8
	SBLVAG1	Retroreflective: polarized beam (anti-glare)	15 feet	1 millisecond	p. 8
	SBL1	Retroreflective: high speed, infrared beam	30 feet	1 millisecond	p. 8
	SBLX1	Retroreflective: high power, long range	100 feet	10 milliseconds	p. 8
	SBD1	Diffuse (proximity): high speed	12 inches	1 millisecond	p. 9
SBDL1	Diffuse (proximity): medium range	24 inches	1 millisecond	p. 9	
SBDX1	Diffuse (proximity): high power, long range	6 feet	10 milliseconds	p. 9	
SBDX1MD	Diffuse (proximity): wide beam angle	24 inches	10 milliseconds	p. 9	
SBCV1	Convergent beam: high speed, visible red	1.5-inch focus	1 millisecond	p. 10	
SBCVG1	Convergent beam: high speed, visible green	1.5-inch focus	1 millisecond	p. 10	
SBC1	Convergent beam: high speed, infrared	1.5-inch focus	1 millisecond	p. 10	
SBC1-4	Convergent beam: high speed, infrared	4-inch focus	1 millisecond	p. 10	
SBC1-6	Convergent beam: high speed, infrared	6-inch focus	1 millisecond	p. 10	
SBCX1	Convergent beam: high power, infrared	1.5-inch focus	10 milliseconds	p. 10	
SBCX1-4	Convergent beam: high power, infrared	4-inch focus	10 milliseconds	p. 10	
SBCX1-6	Convergent beam: high power, infrared	6-inch focus	10 milliseconds	p. 10	
SBEF & SBRF1	Opposed fiber optic (glass fibers): high speed	see specs	1 millisecond	p. 11	
SBEXF & SBRXF1	Opposed fiber optic (glass fibers): high power	see specs	10 milliseconds	p. 11	
SBFX1	Fiber optic (glass fibers): high power, infrared	see specs	10 milliseconds	p. 11	
SBF1	Fiber optic (glass fibers): high speed, infrared	see specs	1 millisecond	p. 12	
SBF1MHS	Fiber optic (glass fibers): very high speed	see specs	0.3 millisecond	p. 12	
SBFV1	Fiber optic (glass fibers): visible red	see specs	1 millisecond	p. 13	
SBFVG1	Fiber optic (glass fibers): visible green	see specs	1 millisecond	p. 13	
SBAR1	Ambient light receiver	see specs	10 milliseconds	p. 14	
SBAR1GH	Ambient light receiver: high gain	see specs	10 milliseconds	p. 14	
SBAR1GHF	Ambient light receiver: for glass fiber optics	see specs	10 milliseconds	p. 14	

MULTI-BEAM 3- & 4-wire Scanner Blocks

Sensing Mode

Models

Excess Gain

Beam Pattern

OPPOSED Mode

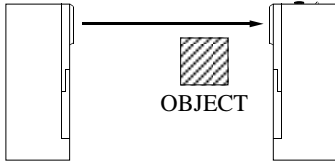

SBE/SBR1: this opposed pair has the highest gain available at 1 ms response.

SBED/SBRD1: fast response and small effective beam; will detect objects as small as .14 inch in crosssection moving at up to 10 feet per second. Best choice for repeatability of position sensing.

SBEX/SBRX1: best choice for opposed sensing in extremely dirty environments. Use for outdoor applications and all applications requiring opposed range of 100 feet or more. Also useable side-by-side for long-distance mechanical convergent sensing. Alignment difficult beyond 400 feet.

SBEV/SBRX1: SBEV has visible red beam for easiest alignment and system monitoring.

SBEXD/SBRXD1: wide beam angle and high gain for the most forgiving emitter-receiver alignment.



SBE & SBR1

Range: 150 feet (45m)
Response: 1ms on/off
Repeatability: 0.03ms
Beam: infrared, 940nm
Effective beam: 1" dia.

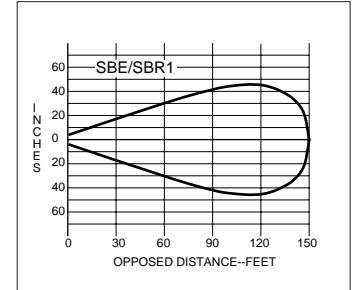
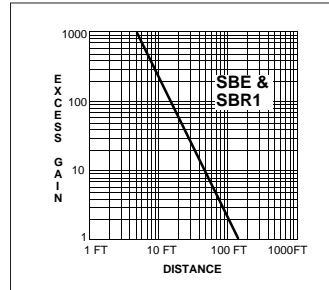

SBED & SBRD1

Range: 10 feet (3m)
Response: 1ms on/off
Repeatability: 0.03ms
Beam: infrared, 880nm
Effective beam: .14" dia.

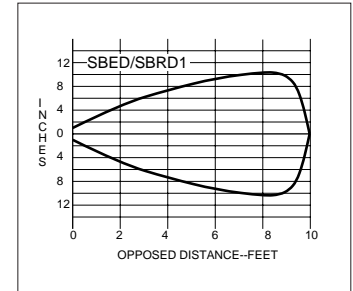
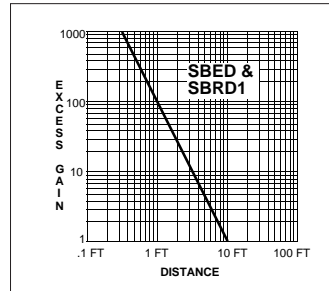

SBEX & SBRX1

Range: 700 feet (200m)
Response: 10ms on/off
Repeatability: 0.7ms
Beam: infrared, 940nm
Effective beam: 1" dia.

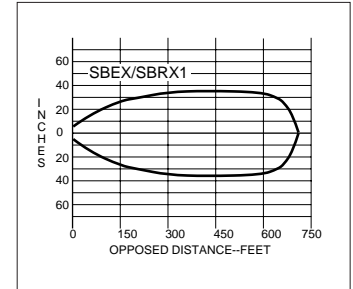
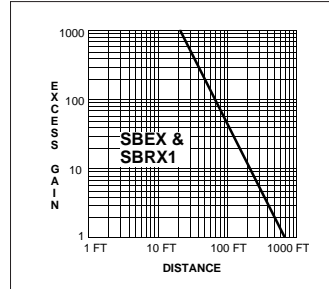

SBEV & SBRX1

Range: 100 feet (30m)
Response: 10ms on/off
Repeatability: 0.1ms
Beam: visible red, 650nm
Effective beam: 1" dia.

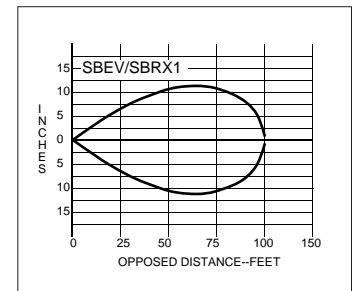
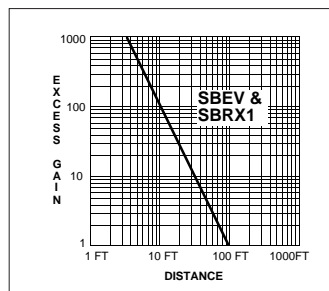

SBEXD & SBRXD1

Range: 30 feet (9m)
Response: 10ms on/off
Repeatability: 0.7ms
Beam: infrared, 880nm
Effective beam: .14" dia.

